

Instruction Manual

Model PD663

## **Loop Powered Indicator**

Explosion Proof

M396A

March 2025

JOWA USA, Inc.  
Littleton, MA 01460 USA  
Tel: 978-486-9800  
[www.jowa-usa.com](http://www.jowa-usa.com)



# PD663 Explosion-Proof NEMA 4X, IP68 Loop-Powered Meter Instruction Manual





## Process Meter

- Explosion-Proof / Flame-Proof Loop-Powered Process Meter
- 4-20 mA Input
- 0.6" (15.2 mm) 3½+ Digits LCD Display; -1999 to 2999
- 1.7 Volt Drop
- HART® Protocol Transparent
- Loop-Powered Backlight Option
- Operates from -40 to 75°C (-40 to 167°F)
- Four Internal Buttons for Easy Field Scaling
- Display Mountable at 0°, 90°, 180°, & 270° Degrees
- Flanges for Wall or Pipe Mounting
- Explosion-Proof, IP68, NEMA 4X Die-Cast Aluminum Enclosure
- FM Approved as Explosion-Proof / Dust-Ignition Proof / Flame-Proof
- CSA Certified as Explosion-Proof / Dust-Ignition Proof / Flame-Proof
- ATEX and IECEx Certified as Flame-Proof and Protection by Enclosure
- Conformal Coated PCBs for Dust and Humidity Protection
- Two ½" NPT Threaded Conduit Openings (One Plug Installed)

### Disclaimer

The information contained in this document is subject to change without notice. Precision Digital makes no representations or warranties with respect to the contents hereof; and specifically disclaims any implied warranties of merchantability or fitness for a particular purpose.

	<b>CAUTION:</b> <i>Read complete instructions prior to installation and operation of the meter.</i>
	<b>WARNING:</b> <i>Risk of electric shock or personal injury</i>



### Warnings

- This product is not recommended for life support applications or applications where malfunctioning could result in personal injury or property loss. Anyone using this product for such applications does so at his/her own risk. Precision Digital Corporation shall not be held liable for damages resulting from such improper use.
- Failure to follow installation guidelines could result in death or serious injury. Make sure only qualified personnel perform the installation.
- Never remove the meter cover in explosive environments when the circuit is live.
- Cover must be fully engaged to meet flameproof/explosion-proof requirements.
- Cancer and Reproductive Harm  
*www.P65Warnings.ca.gov*. For California Proposition 65 details please visit our website *www.predig.com*

### Limited Warranty

Precision Digital Corporation warrants this product against defects in material or workmanship for the specified period under "Specifications" from the date of shipment from the factory. Precision Digital's liability under this limited warranty shall not exceed the purchase value, repair, or replacement of the defective unit.

### Registered Trademarks

All trademarks mentioned in this document are the property of their respective owners.

© 2013-2018 Precision Digital Corporation. All rights reserved.

[www.predig.com](http://www.predig.com)

### Introduction

The PD663 is a loop-powered field meter that is FM Approved and CSA Certified as Explosion-Proof, Dust-Ignition Proof, and Flame-Proof, and ATEX & IECEx Certified as Flame-Proof and Protection by Enclosure. The PD663 is easy to install and program and it can be seen in a variety of lighting conditions and even in bright sunlight. The fact that this meter is loop-powered means that there is no need to run additional, costly power lines into a hazardous area. The meter gets all of the power it needs from the 4-20 mA loop and its 1.7 V drop results in a minimal burden on the loop.

The meter features a wide -40 to 75°C operating temperature range and comes with two 1/2" NPT threaded conduit openings and flanges for wall or pipe mounting. Calibration is a quick process involving the four internal push buttons. The PD663's display will read up to 2999; we call this 3½+ digits!

### Ordering Information

Model	Options Installed
PD663	None

## Table of Contents

Introduction .....	2
Ordering Information .....	2
<b>SPECIFICATIONS .....</b>	<b>4</b>
Input .....	4
Product Ratings and Approvals.....	5
Electromagnetic Compatibility .....	5
<b>Safety Information .....</b>	<b>5</b>
<b>Installation.....</b>	<b>6</b>
Unpacking .....	6
Pre-Installed Conduit Plug .....	6
Mounting .....	6
Cover Jam Screw .....	6
Connections .....	7
4-20 mA Input Connections & Wiring Diagrams .....	7
<b>Setup and Programming.....</b>	<b>8</b>
Buttons and Display .....	8
Setting Numeric Values .....	8
Programming the Meter .....	8
Main Menu .....	9
Main Menu Display Functions & Messages .....	9
Setting the Decimal Point ( <i>dP</i> ) .....	10
Scaling the Meter ( <i>SEL</i> ) .....	10
Calibrating the Meter ( <i>ERL</i> ) .....	10
Re-calibrating the Internal Calibration Reference ( <i>iERL</i> ) .....	11
Advanced Features Menu .....	11
Advanced Features Menu & Display Messages .....	11
Signal Input Conditioning Function ( <i>FUNC</i> ).....	12
Information Menu (info).....	12
Input Signal Filter ( <i>FIL</i> ) .....	12
Internal Calibration ( <i>iERL</i> ) .....	12
<b>OPERATION.....</b>	<b>13</b>
Front Panel Buttons Operation.....	13
Maximum & Minimum Readings ( <i>H I &amp; L D</i> ) .....	13
Reset Meter to Factory Defaults .....	14
Factory Defaults & User Settings.....	14
<b>TROUBLESHOOTING .....</b>	<b>15</b>
Troubleshooting Tips.....	15
<b>MOUNTING DIMENSIONS .....</b>	<b>15</b>
<b>QUICK USER INTERFACE REFERENCE .....</b>	<b>16</b>
<b>EU Declaration of Conformity.....</b>	<b>17</b>

## Table of Figures

Figure 1. PD663 Meter Assembly, Rear View.....	7
Figure 2. PD663 Input Connections without Backlight .....	7
Figure 3. PD663 Input Connections with Backlight .....	7
Figure 4. Enclosure Dimensions – Front View ....	15
Figure 5. Enclosure Dimensions – Side Cross Section View .....	15

## Specifications

Except where noted all specifications apply to operation at +25°C. General

<b>DISPLAY</b>	0.6" (15.2 mm) LCD, 3½+ digits; -1999 to 2999
<b>DISPLAY UPDATE RATE</b>	2 Updates/Second
<b>OVERRANGE</b>	Display flashes <b>2999</b>
<b>UNDERRANGE</b>	Display flashes <b>- 1999</b>
<b>PROGRAMMING METHOD</b>	Four internal pushbuttons
<b>NOISE FILTER</b>	Programmable <b>H I, LO,</b> or <b>OFF</b>
<b>RECALIBRATION</b>	Recalibration is recommended at least every 12 months.
<b>MAX/MIN DISPLAY</b>	Max/Min readings reached by the process are stored until reset by the user or until power to the meter is turned off.
<b>NON-VOLATILE MEMORY</b>	All programmed settings are stored in non-volatile memory for a minimum of ten years if power is lost.
<b>NORMAL MODE REJECTION</b>	64 dB at 50/60 Hz
<b>ENVIRONMENTAL</b>	Operating temperature range: -40 to 75°C Storage temperature range: -40 to 75°C Relative humidity: 0 to 90% non-condensing
<b>CONNECTIONS</b>	Removable screw terminals accept 12 to 22 AWG wire
<b>ENCLOSURE</b>	Explosion-proof die cast aluminum with glass window, 0.30% max copper content, corrosion resistant epoxy coating, color: blue. NEMA 4X, 7, & 9, IP68.  Two ½" NPT threaded conduit openings. One ½" NPT nickel plated brass conduit plug with 10 mm hex key fitting installed.
<b>MOUNTING</b>	May be mounted directly to conduit. Two mounting holes for 1.5" pipe or wall mounting. See Mounting Dimensions on page 15.
<b>TIGHTENING TORQUE</b>	Screw terminal electrical connectors: 4.5 lb-in (0.5 Nm)
<b>OVERALL DIMENSIONS</b>	4.84" x 4.29" x 3.62" (123 mm x 109 mm x 92 mm) (W x H x D)
<b>WEIGHT</b>	2.45 lbs (40 oz, 1.13 kg)
<b>WARRANTY</b>	3 years parts and labor

## Input

<b>ACCURACY</b>	±1 count	
<b>FUNCTION</b>	Linear (2 to 32 points) or square root	
<b>TEMPERATURE DRIFT</b>	50 PPM/°C from -40 to 75°C ambient	
<b>DECIMAL POINT</b>	User selectable decimal point	
<b>MINIMUM SPAN</b>	Input 1 & Input 2: 0.40 mA	
<b>CALIBRATION RANGE</b>	An <i>Error</i> message will appear if input 1 and input 2 signals are too close together.	
	<b>Input Range</b>	<b>Minimum Span Input 1 &amp; Input 2</b>
	4-20 mA	0.40 mA
<b>MAXIMUM VOLTAGE DROP</b>	1.7 VDC @ 20 mA	
<b>EQUIVALENT RESISTANCE</b>	85 Ω @ 20 mA	
<b>INPUT OVERLOAD</b>	Over current protection to 2 A max.	
<b>HART TRANSPARENCY</b>	Analog input will not interfere with existing HART communications on the wired 4-20 mA signal	

## Product Ratings and Approvals

**FM** Explosion-proof for Class I, Division 1, Groups B, C and D  
 Dust-ignition proof for Class II/ III, Division 1, Groups E, F and G; T6  
 Flame-proof for use in Class I, Zone 1, AEx d Group IIC; T6  
 Protection by Enclosure, Zone 21, AEx tb IIIC; T85°C  
 Ta = -40 to 75°C.  
 Enclosure: Type 4X, IP66.  
 Certificate number: 3040391

**ATEX & IECEx** II 2 G D. Flame-proof for use in Zone 1, Ex d IIC T6 Gb  
 Protection by Enclosure for use in Dust Atmospheres (Zone 21)  
 Ex tb IIIC T85°C Db IP68.  
 Ta = -40 to +75°C  
 ATEX Certificate Number: Sira 10ATEX1116X  
 IECEx Certificate Number: IECEx SIR 10.0056X

**CSA** Explosion-proof for use in Class I, Division 1, Groups B, C and D  
 Dust-ignition proof for use in Class II/III, Division 1, Groups E, F and G; T6  
 Flame-proof for use in Zone 1, Ex d IIC T6  
 Ta = -40 to 75°C.  
 Enclosure: Type 4X & IP66/IP68.  
 Certificate number: 2325749

### Special Conditions for Safe Use:

Use suitably certified and dimensioned cable entry device and/or plug. The equipment shall be installed such that the supply cable is protected from mechanical damage. The cable shall not be subjected to tension or torque. If the cable is to be terminated within an explosive atmosphere, then appropriate protection of the free end of the cable shall be provided.

### Year of Construction

This information is contained within the serial number with the first four digits representing the year and month in the YYMM format.

**For European Community:** The PD663 must be installed in accordance with the ATEX directive 94/9/EC and the product certificate Sira 10ATEX1116X.

## Electromagnetic Compatibility

<b>EMISSIONS</b>	EN 61326:2013 Safety requirements for measurement, control, and laboratory use – Industrial Group 1 Class A ISM emissions requirements
Radiated Emissions	Class A
<b>IMMUNITY</b>	EN 61326:2013 Safety requirements for measurement, control, and laboratory use
ESD	±4 kV contact, ±8 kV air
RFI – Amplitude Modulated	80-1000 MHz @ 10 V/m, 1.4-2.0 GHz @ 3 V/m, 2.0-2.7 GHz @ 1 V/m, 80% AM (1 kHz)
EFT	±2 kV DC mains, ±1 kV other
Telco Surge	±1 kV
CRFI	3 V, 0.15-80 MHz, 1 kHz 80% AM

## Safety Information



### WARNINGS

- Read complete instructions prior to installation and operation of the meter.
- Installation and service should be performed only by trained service personnel. Service requiring replacement of internal components must be performed at the factory.
- Disconnect from supply before opening enclosure. Keep cover tight while circuits are alive. Conduit seals must be installed within 18" (450mm) of the enclosure.
- Verify that the operating atmosphere of the meter is consistent with the appropriate hazardous locations certifications.
- If the meter is installed in a high voltage environment and a fault or installation error occurs, high voltage may be present on any lead

## Installation

**For Installation in USA:** The PD663 must be installed in accordance with the National Electrical Code (NEC) NFPA 70.

**For Installation in Canada:** Install in accordance with applicable local and national regulations (e.g. NEC). The PD663 must be installed in accordance with the Canadian Electrical Code CSA 22.1. All input circuits must be derived from a CSA approved Class 2 source.

**For European Community:** The PD663 must be installed in accordance with the ATEX directive 94/9/EC and the product certificate Sira 10ATEX1116X.

All pushbuttons and wiring connectors are accessed by opening the enclosure. To access electrical connectors, remove the 2 captive screws and remove the meter assembly.



**WARNING:** Disconnect from supply before opening enclosure. Keep cover tight while circuits are alive. Conduit seals must be installed within 18" (450 mm) of the enclosure.

## Unpacking

Remove the meter from box. Inspect the packaging and contents for damage. Report damages, if any, to the carrier.

If any part is missing or the meter malfunctions, please contact your supplier or the factory for assistance.

## Pre-Installed Conduit Plug

The PD663 is supplied with one pre-installed optional conduit plug for installations that do not require the use of both conduit entries. The conduit plug includes an internal hexagonal socket recess for removal. The pre-installed plug and installation are included in all hazardous area approvals of the PD663.



**WARNING:** Installations of the supplied conduit plug require the application of non-setting (solvent free) thread sealant. If the pre-installed conduit plug is removed or replaced all relevant hazardous area guidelines must be followed for its installation or replacement conduit.

## Mounting

The PD663 has two mounting holes that may be used for a 1.5" pipe mounting or wall mounting. Alternatively, the unit may be supported by the conduit using the conduit holes provided.

It can also be pipe mounted by using the PDA6863 pipe mount kit for 2" pipe.

Refer to *Mounting Dimensions*, page 15 for details on wall or panel space requirements



**WARNING:** Do not attempt to loosen or remove flange bolts while the meter is in service.

## Cover Jam Screw

The cover jam screw should be properly installed once the meter has been wired and tested in a safe environment. The cover jam screw is intended to prevent the removal of the meter cover in a flameproof environment without the use of tools. Using a M2 hex wrench, turn the screw clockwise until the screw contacts the meter. Turn the screw an additional 1/4 to 1/2 turn to secure the cover. Caution: Excess torque may damage the threads and/or wrench.



## Connections



**WARNINGS**

- Static electricity can damage sensitive components.
- Observe safe handling precautions for static-sensitive components.
- Use proper grounding procedures/codes.
- If the meter is installed in a high voltage environment and a fault or installation error occurs, high voltage may be present on any lead or terminal.

To access the connectors, remove the enclosure cover and unscrew the two captive stainless steel screws. Remove the meter assembly from the enclosure. Signal connections are made to a three-terminal removable connector on the back of the meter assembly. Grounding connections are made to the two ground screws provided on the base – one internal and one external.

<b>S+</b>	4-20 mA signal input positive terminal connection
<b>S-</b>	4-20 mA signal return/negative terminal connection
<b>X</b>	Not connected

See Figure 1 for terminal positions on the rear of the meter assembly.



**WARNING**

Observe all safety regulations. Electrical wiring should be performed in accordance with all agency requirements and applicable national, state, and local codes to prevent damage to the meter and ensure personnel safety.

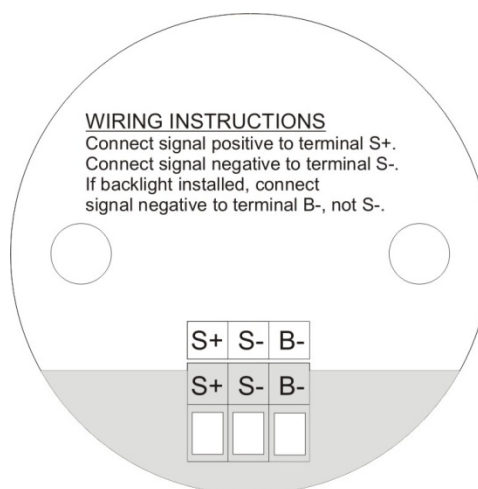

Figure 1. PD663 Meter Assembly, Rear View

### 4-20 mA Input Connections & Wiring Diagrams

Signal input connections are made to a three-terminal connector labeled S+|S-|X for models without a backlight and S+|S-|B- for models with a backlight. The enclosure also provides one internal and one external earth grounding screw. The 4-20 mA input with no backlight has a maximum voltage drop of 1.7 V and is wired as shown in Figure 2. The loop-powered backlight configuration requires a total maximum voltage drop of 4.7 V. The backlight is recommended for dim lighting conditions and is enabled when wired as shown in Figure 3. The enclosure also provides one internal and one external earth grounding screw.

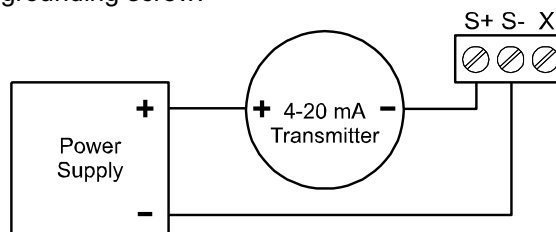

Figure 2. PD663 Input Connections

## Setup and Programming

There is **no need to recalibrate** the meter for milliamps when first received from the factory.

The meter is **factory calibrated** for milliamps prior to shipment. The calibration equipment is traceable to NIST standards.

### Overview

There are no jumpers involved in the setup process of the meter.





Setup and programming is done through the front panel buttons.

After all connections have been completed and verified, apply power to the loop.

For Quick User Interface Reference go to page 16

## Buttons and Display



Button/ Symbol	Description
 <b>MENU</b>	Menu button to enter programming mode. Press and hold for 5 seconds to access the <i>Advanced</i> features of the meter.
 <b>ENTER</b>	Enter button to access a menu or accept a setting.
 <b>RESET</b>	Right arrow to scroll through the menus or move to the next digit or decimal position during programming. Resets the Max or Min display value when pressed while showing Max or Min value.
 <b>MAX</b>	Up arrow to scroll through the menus, decimal point, or to increment the value of a digit. Displays the Max then Min display values when pressed during normal run mode.

## Setting Numeric Values

The numeric values are set using the **Right** and **Up** arrow buttons. Press the **Right** arrow to select next digit and the **Up** arrow to increment digit. The two left-most digits on the display are set as a single digit, able to display -19 to 29.

The digit being changed blinks.

Press the **Enter** button, at any time, to accept a setting or **Menu** button to exit without saving changes.

The decimal point is set using the **Right** or **Up** arrow button in the *Setup-decimal point* menu.

### Programming the Meter

It is **very important** to read the following information, before proceeding to program the meter:

There is **no need to recalibrate** the meter for milliamps when first received from the factory.

The meter is **factory calibrated** for milliamps prior to shipment. The calibration equipment is traceable to NIST standards.

Use the *Scale (5LL)* menu to enter scale parameters without applying a live signal.

Alternatively, use the *Calibrate (LR)* menu to apply a signal from a calibrator or a 4-20 mA transmitter to calibrate the meter.

Inputs may be calibrated or scaled to any display within the range of the meter.

Additional parameters, not needed for most applications, are viewed and programmed with the *Advanced features* menu, see *Advanced Features Menu*, page 11.

## Main Menu

The main menu consists of the most commonly used functions: *Decimal Point Location*, *Scale*, and *Calibration*.

Press **Menu** button to enter Programming Mode then press the **Up Arrow** button to scroll through the main menu.

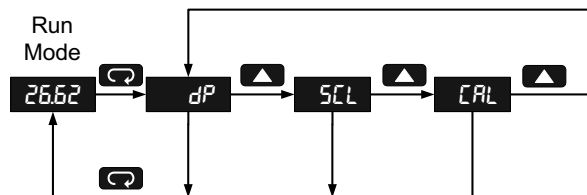

Press **Menu**, at any time, to exit and return to Run Mode. Changes made to settings prior to pressing **Enter** are not saved.

Changes to the settings are saved to memory only after pressing **Enter**.

The display moves to the next menu every time a setting is accepted by pressing **Enter**.

## Main Menu Display Functions & Messages

The meter displays various functions and messages during setup, programming, and operation. The following table shows the main menu functions and messages in the order they appear in the menu.

Display	Parameter	Action/Setting
dP	<i>Decimal point</i>	Set decimal point
SCL	<i>Scale</i>	Enter the <i>Scale</i> menu
nPt	<i>Number of Points</i>	Set number of linearization points
i1	<i>Scale Input 1</i>	Input signal 1 value (mA)
d1	<i>Scale Display 1</i>	Scaled value for input 1
i2	<i>Scale Input 2</i>	Input signal 2 value (mA)
d2	<i>Scale Display 2</i>	Scaled value for input 2
CAL	<i>Calibrate</i>	Enter the <i>Calibrate</i> menu
nPt	<i>Number of Points</i>	Set number of linearization points
i1	<i>Calibrate Input 1</i>	Read input signal 1
d1	<i>Calibrate Display 1</i>	Enter value for input 1
i2	<i>Calibrate Input 2</i>	Read input signal 2
d2	<i>Calibrate Display 2</i>	Enter value for input 2

### Setting the Decimal Point (dP)

Decimal point may be set with up to three decimal places or with no decimal point at all. Pressing the **Right** or **Up** arrow moves the decimal point one place to the right until no decimal point is displayed, then it moves to the left most position.

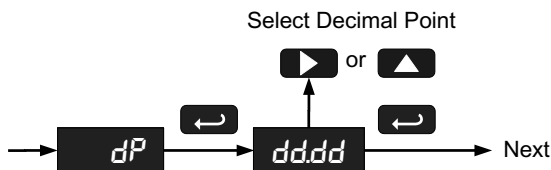

### Scaling the Meter (5CL)

The 4-20 mA input can be scaled to display the process in engineering units.

A signal source is not needed to scale the meter; simply program the inputs and corresponding display values.

If using linear signal input conditioning, enter the number of scale points (2-32), followed by the input values and display values. If using square root signal input conditioning, the number of points input menu will not be present.

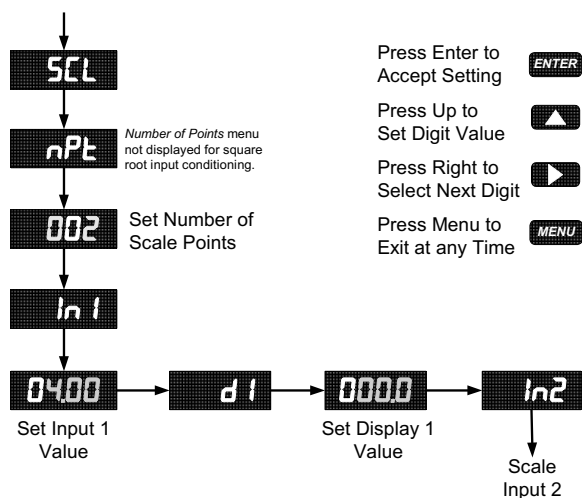

#### Number of Points (nPt)

Set the number of linearization points used in the *Scale* menu. 2 to 32 points may be used. The *Scale* menu is entered after entering the number of points.

For instructions on how to program numeric values see *Setting Numeric Values*, page 8

### Minimum Input Span

The minimum input span is the minimum difference between input 1 and input 2 signals required to complete the calibration or scaling of the meter. The minimum span is 0.40 mA.

If the minimum span is not maintained, the meter reverts to input 2, allowing the appropriate input signals to be applied.

### Calibrating the Meter (CAL)

To scale the meter without a signal source refer to *Scaling the Meter (5CL)*, page 10.

The meter can be calibrated to display the process in engineering units by applying the appropriate input signal and following the calibration procedure.

The use of a calibrated signal source is strongly recommended.

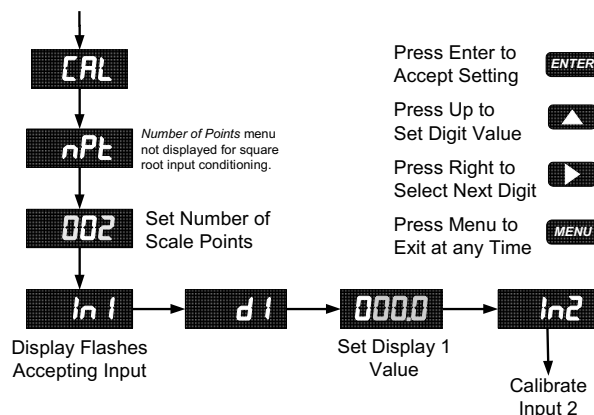

Press the **Up** arrow button to scroll to the *Calibration* menu (CAL) and press **Enter**.

If using linear signal input conditioning, enter the number of calibration points (2-32).

The meter displays *in 1*. Apply a known signal and press **Enter**. The display will flash while accepting the signal.

When the meter displays *d 1*, press **Enter**. Enter a corresponding display value for the signal input, and press **Enter** to accept.

The meter displays *in 2*. Apply a known signal and press **Enter**. The display will flash while accepting the signal.

When the meter displays *d 2*, press **Enter**. Enter a corresponding display value for the signal input, and press **Enter** to accept.

### Re-calibrating the Internal Calibration Reference ( *iCAL* )

The *Internal Calibration ( iCAL )* menu, located in the *Advanced* features menu, is used to recalibrate the internal calibration reference. Recalibration is recommended at least every twelve months. Refer to Internal Calibration ( *iCAL* ], page 12 for instructions.

### Advanced Features Menu

To simplify the setup process, functions not needed for most applications are located in the *Advanced* features menu. Press and hold the **Menu** button for five seconds to access the *Advanced* features menu

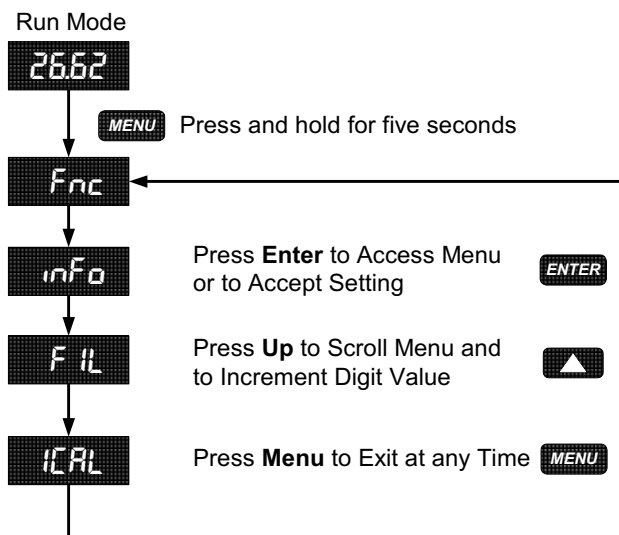

### Advanced Features Menu & Display Messages

The following table shows the *Advanced* features menu functions and messages in the order they appear in the menu.

Display	Parameter	Action/Setting
<i>Fnc</i>	<i>Input Function</i>	Set linear or square root input conditioning function
<i>Lnr</i>	<i>Linear</i>	Set linear scaling
<i>Sqr</i>	<i>Square Root</i>	Set square root input conditioning function
<i>Info</i>	<i>Information</i>	Enter the <i>Information</i> menu
<i>Sft</i>	<i>Software Information</i>	Software release number
<i>Ver</i>	<i>Version</i>	Meter firmware version
<i>°C</i>	<i>Calibration Temp (°C)</i>	Temperature at time of I-calibration (°C)
<i>°F</i>	<i>Calibration Temp (°F)</i>	Temperature at time of I-calibration (°F)
<i>FIL</i>	<i>Filter</i>	Set filter function level
<i>iCAL</i>	<i>I-Calibration</i>	Internal master factory calibration
<i>rst</i>	<i>Reset Defaults</i>	Restore factory default parameter settings

## Signal Input Conditioning Function (FnL)

The PD663 provides linear and square root signal input conditioning functions for inputs from linear and non-linear transmitters.

### Linear (Lnr)

Meters are set up at the factory for linear function using two-point linearization. Multi-point linearization with up to 32 points may be used. The linear function provides a display that is linear with respect to the input signal between each set of input points.

### Square Root (59r)

The square root function is used to linearize the signal from a differential pressure transmitter and display flow rate in engineering units.

## Information Menu (info)

The *Information* menu is located in the *Advanced* features menu, to access *Information* menu see *Advanced Features Menu*, page 11.

It shows software identification number, version number, and calibration temperatures. To determine the software version of a meter:

Go to the *Information* menu (FnFa) and press **Enter** button.

The meter will automatically scroll through the software release number and software version. The meter temperatures at the time of last internal calibration in °C and °F are displayed for calibration troubleshooting. Pressing the **Enter**, **Right**, or **Up** buttons will progress the information display.

Following the information display, the meter will exit the *Advanced* features menu and return to run mode.

## Input Signal Filter (F IL)

The noise filter is available for unusually noisy signals that cause an unstable process variable display. The noise filter averages the input signal over a certain period. The filter level can be set to low (L0), high (H1), or off (OFF). The higher the filter setting, the longer the averaging time and so the longer the display may take to find its final value.

The filter contains a noise filter bypass feature so that while small variations in the signal will be filtered out, large, abrupt changes to the input signal are displayed immediately.

## Internal Calibration (iCAL)

There is **no need to recalibrate** the meter for milliamps when first received from the factory. The meter is **factory calibrated** for milliamps prior to shipment. The calibration equipment is traceable to NIST standards.

The internal calibration allows the user to scale the meter without applying a signal. The use of a calibrated signal source is necessary to perform the internal calibration of the meter. Check calibration of the meter at least every 12 months.

### Notes:

The signal source must have a full-scale accuracy of 0.01% or better between 4 and 20 mA in order to maintain the specified accuracy of the meter.

Allow the meter to warm up for at least 15 minutes before performing the internal calibration procedure.

The *Internal calibration* menu is part of the *Advanced* features menu.

Press and hold the **Menu** button for 5 seconds to enter the *Advanced* features menu. Press the **Up** arrow button to scroll to the *Internal Calibration* menu (iCAL) and press **Enter**.





The meter displays 4.00 mA. Apply a 4.00 mA signal and press **Enter**. The display flashes for a moment while the meter is accepting the signal. After the signal is accepted, the meter displays 20.00 mA. Apply a 20.00 mA signal and press **Enter**. The display flashes for a moment while the meter is accepting the signal.

## Error Message (Err)

An error message indicates that the calibration process was not successful. After the error message is displayed, the meter will revert to input 2 calibration settings. The error message might be caused by inadvertently leaving the signal at the previous level or not maintaining a 0.40 mA minimum span. Press the **Menu** button to cancel the current calibration process if necessary.

## OPERATION

### Front Panel Buttons Operation

Button Symbol	Description
 MENU	Press to enter or exit Programming Mode or exit Max/Min readings.
 ENTER	Press to indefinitely display Max or Min until Menu button is pressed.
 RESET	Press to reset Max or Min reading.
 MAX	Press to display Max/Min readings alternately.

### Maximum & Minimum Readings (HI & LO)

The maximum and minimum (peak & valley) readings reached by the process are stored in the meter since the last reset or power-up. The meter flashes HI or LO to differentiate between run mode and max/min display.

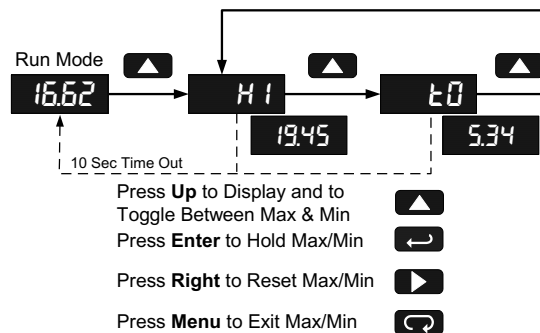

Press **Up** arrow button to display maximum reading since the last reset/power-up.

Press **Up** arrow again to display the minimum reading since the last reset/power-up.

Press **Enter** to continue to display the Max or Min display reading by disabling the Max/Min timeout. The meter will continue to track new Max/Min readings. Press MENU to exit the Max/Min reading.

If **Enter** is not pressed, the Max/Min display reading will continue to flash and time out after ten seconds. The meter will return to display the actual reading.

Press **Right** arrow button while in Max/Min Mode to reset both Max and Min. Max/Min display readings are reset to the current reading.

## Reset Meter to Factory Defaults

When the parameters have been changed in a way that is difficult to determine what's happening, it might be better to start the setup process from the factory defaults.

Instructions to load factory defaults:

Enter the *Advanced* features menu. See Advanced Features Menu, page 11.

Press **Up** arrow button to display *FnC* menu.

Press **Right** arrow button when *FnC* is shown.

Press **Enter** button when *rSt* is shown.

Press **Enter** again when display flashes *rSt*.

Note: If **Enter** is not pressed a second time within three seconds, *rSt* will stop flashing and the last **Enter** press cancelled.

The meter goes through an initialization sequence (same as on power-up), and loads the factory default settings.

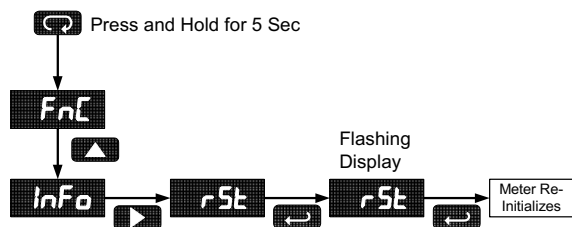

## Factory Defaults & User Settings

The following table shows the factory setting for most of the programmable parameters on the meter. Next to the factory setting, the user may record the new setting for the particular application.

Model: \_\_\_\_\_

S/N: \_\_\_\_\_

Date: \_\_\_\_\_

Parameter	Display	Default Setting	User Setting
Decimal point	<i>ddd</i>	2 places	
Scale	<i>SL</i>		
Number of Points	<i>nPt</i>	2	
Input 1	<i>in 1</i>	4.00 mA	
Display 1	<i>d 1</i>	4.00	
Input 2	<i>in 2</i>	20.00 mA	
Display 2	<i>d 2</i>	20.00	
<i>Advanced Features</i>			
Input Conditioning Function	<i>Fnc</i>	Linear	
Filter	<i>F IL</i>	Off	



## TROUBLESHOOTING

The rugged design and the user-friendly interface of the meter should make it unusual for the installer or operator to refer to this section of the manual. If the meter is not working as expected, refer to the recommendations below.

### Troubleshooting Tips

Symptom	Check/Action
No display or faint display	Check input signal connections. Perform hard reset by shorting S+ and S- terminals.
Rate display unsteady	Increase filter setting in <i>Advanced</i> menu.
Meter displays error message during calibration ( <i>Err</i> )	Check signal connections. Verify minimum input span requirements
Meter flashes 2999 or -1999	Check input signal within scaled range of 2999 and -1999.
Display stuck flashing a number and <i>H I</i> or <i>L O</i>	Press <b>Menu</b> to exit Max/Min display readings.
Display response is too slow	Check filter setting to see if it can be lowered to <i>L O</i> or <i>OFF</i> .
If the display locks up or the meter does not respond at all	Perform hard reset by shorting S+ and S- terminals.
Other symptoms not described above	Call Technical Support for assistance.

## MOUNTING DIMENSIONS

All units: inches [mm]

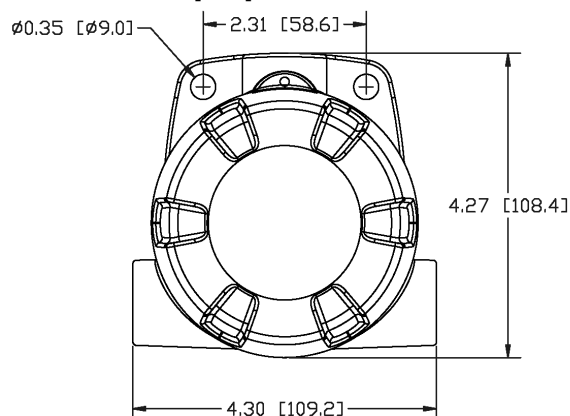

Figure 4. Enclosure Dimensions – Front View

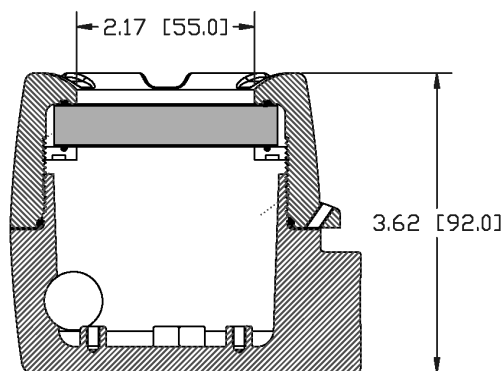

Figure 5. Enclosure Dimensions – Side Cross Section View

**Note:** The supplied conduit plug may extend up to 0.6 in [15 mm] from the conduit opening when installed.

## QUICK USER INTERFACE REFERENCE

<u>Pushbutton</u>	<u>Function</u>
<b>Menu</b>	Go to Programming Mode, leave Programming Mode, and Max/Min Mode. Hold for 5 seconds to access <i>Advanced</i> Features.
<b>Right Arrow</b>	Move to next digit or decimal point position. Reset Min/Max.
<b>Up Arrow</b>	Move to next selection or increment digit. Go to Max/Min Mode.
<b>Enter</b>	Accept selection/value and move to next selection.

### Max/Min Mode

While in Run Mode, pressing **Up Arrow** will initiate Max/Min Mode. **Up Arrow** toggles between Max & Min displays, and **Right Arrow** resets the Max/Min to the current value. Press **Menu** or wait 10 seconds to return to Run Mode. Pressing **Enter** will disable the 10 second timeout and continuously flash Max or Min.

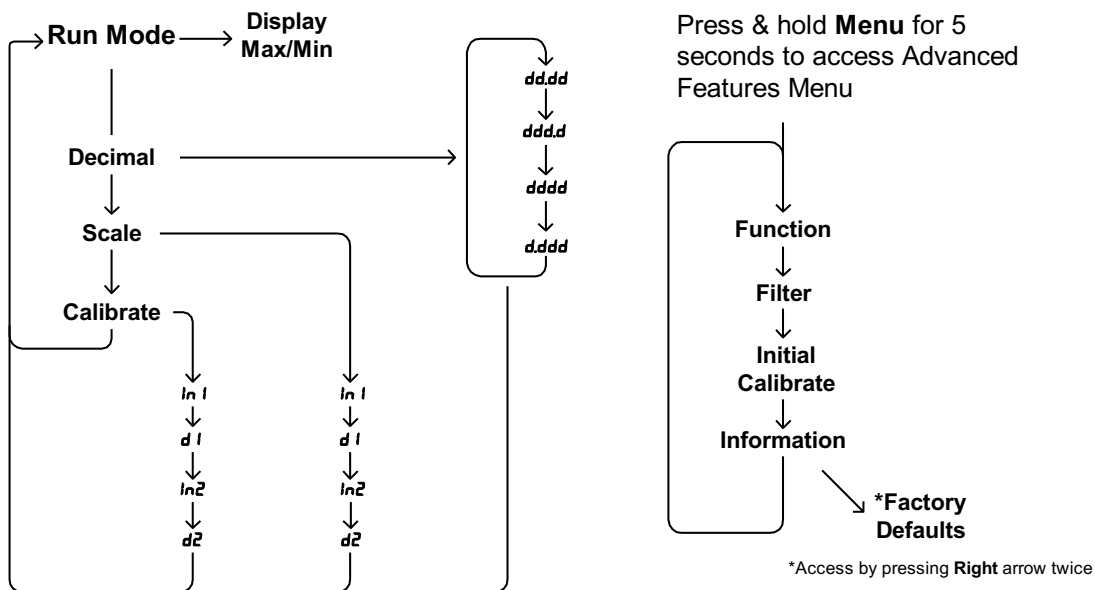

### Operational Modes

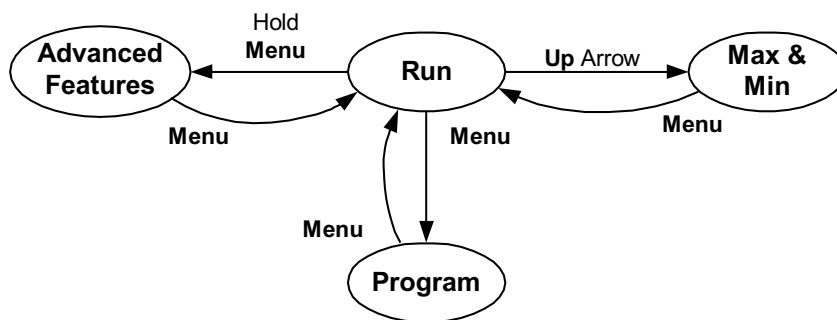

## How to Contact JOWA USA, Inc.

- For Technical Support please  
Call: +1-978-486-9800  
Email: [service@jowa-usa.com](mailto:service@jowa-usa.com)
- For Sales Support or to place an order please  
Call: +1-978-486-9800  
Email: [sales@jowa-usa.com](mailto:sales@jowa-usa.com)
- For the latest version of this manual please visit  
**[www.jowa-usa.com](http://www.jowa-usa.com)**

